

Le Bacinelle - art. SHBA45

bacinella da appoggio
on-top bowl

cielo



PESO NETTO/NET WEIGHT: 9,05 Kg

PCS PALLET: 32

PCS PALLET CONTAINER: 64

ACCESSORI/ACCESSORIES:

PIL01 - Piletta universale click-clack CROMO con coperchio in ceramica / Universal click-clack drain in CHROME with ceramic lid

PIL01NM - Piletta universale click-clack NERO MATT con coperchio in ceramica / Universal click-clack drain in MATT BLACK with ceramic lid

PIL01BR - Piletta universale click-clack BRONZO con coperchio in ceramica / Universal click-clack drain in BRONZE with ceramic lid

PIL01CM - Piletta universale click-clack CEMENTO con coperchio in ceramica / Universal click-clack drain in CEMENTO with ceramic lid

SISP - Sifone CROMO / CHROME siphon

SIFN - Sifone NERO MATT / MATT BLACK siphon





SIFBR - Sifone BRONZO / BRONZE siphon

SIFCM - Sifone CEMENTO / CEMENTO siphon

FINITURE

FINISHES

Essential colors

-  Bianco/white - glossy
-  Nero/black - glossy
-  Fumo - glossy
-  Talpa - glossy

Le Terre di Cielo

-  Talco
-  Pomice
-  Brina
-  Basalto
-  Lavagna
-  Cemento
-  Fango
-  Cacao
-  Arenaria
-  Avena
-  Lino
-  Agave
-  Muschio
-  Polvere
-  Cipria
-  Canapa

Le Acque di Cielo

-  Oltremare
-  Smeraldo
-  Alga
-  Corallo
-  Ninfea
-  Anemone



DoP No. 14688.01

Luglio 2025

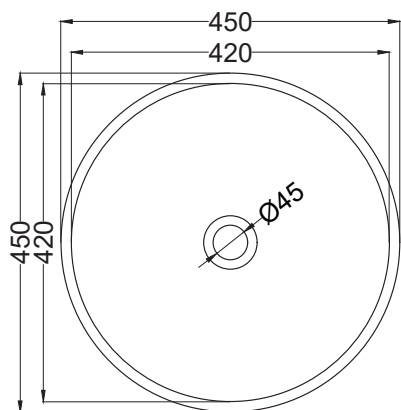

TOP

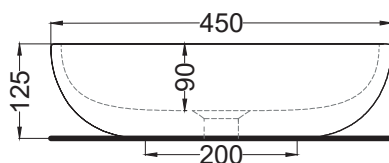

SIDE

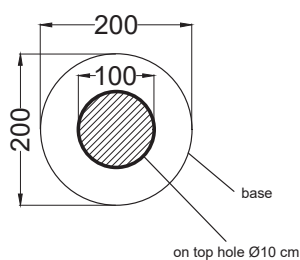

ATTENZIONE:
Superfici, pesi e misure riportate possono presentare leggere differenze rispetto ai pezzi reali, in considerazione e accordo delle caratteristiche di tolleranza intrinseche del materiale ceramico e del suo processo produttivo. L'azienda si riserva di cambiare schede tecniche e caratteristiche di funzionamento degli articoli in ogni momento e senza necessità di preavviso.

ATTENTION:
Surfaces, weights and dimensions can show some little differences compared to the real item, following typical intrinsic characteristics of ceramics material and production. The company reserves the right to change any technical specifications/ dimension and/or operating characteristics of the products at any time and without giving notice.