

# I Catini - Catino rettangolare 80

# cielo

## FINITURE LAVABO / WASHBASIN FINISHES

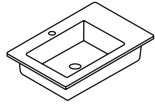

### Essential colors

- Bianco / white - glossy
- Nero / black - glossy
- Fumo - glossy
- Talpa - glossy
- Cioccolato - glossy

### Le Terre di Cielo

- Talco
- Pomice
- Brina
- Basalto
- Lavagna
- Cemento
- Fango
- Cacao
- Arenaria
- Avena
- Lino
- Agave

### Le Acque di Cielo

- Oltremare
- Smeraldo
- Alga
- Corallo
- Ninfea
- Anemone

## FINITURE STRUTTURA / FRAMEWORK FINISHES



- Nero Matt / matt black
- Cemento
- Bronzo Spazzolato / brushed bronze

### Essential colors

- Fumo - glossy
- Talpa - glossy

### Le Acque di Cielo

- Oltremare
- Smeraldo
- Alga
- Corallo
- Ninfea
- Anemone

## FINITURE MOBILE E PIANO / CABINET AND SHELF FINISHES

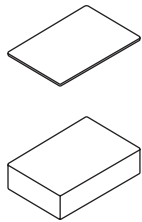

### Essential colors

- Fumo - glossy
- Talpa - glossy

### Le Terre di Cielo

- Talco
- Pomice
- Brina
- Basalto
- Cemento
- Arenaria
- Avena
- Agave
- Muschio

### Le Acque di Cielo

- Oltremare
- Smeraldo
- Alga
- Corallo
- Ninfea
- Anemone

### Essenze / wood essences

- Rovere Sbiancato
- Rovere Naturale
- Rovere Nero
- Rovere Tinto Noce
- Eucalipto

## FINITURE PIANO IN MARMO / MARBLE SHELF FINISHES

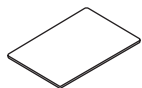

- Bianco Carrara Gioia
- Nero Marquinia
- Azul Noche

## ACCESSORI / ACCESSORIES

### Pilette / click-clack drains:

**PIL01 - Piletta universale click-clack CROMO con coperchio in ceramica**  
Universal click-clack drain in CHROME with ceramic lid

**PIL01NM - Piletta universale click-clack NERO MATT con coperchio in ceramica**  
Universal click-clack drain in MATT BLACK with ceramic lid

**PIL01BR - Piletta universale click-clack BRONZO con coperchio in ceramica**  
Universal click-clack drain in BRONZE with ceramic lid

**PIL01CM - Piletta universale click-clack CEMENTO con coperchio in ceramica**  
Universal click-clack drain in CEMENTO with ceramic lid

### Sifoni / siphons:

**SISP - Sifone CROMO**  
CHROME siphon

**SIFN - Sifone NERO MATT**  
MATT BLACK siphon

**SIFBR - Sifone BRONZO**  
BRONZE siphon

**SIFCM - Sifone CEMENTO**  
CEMENTO siphon

# I Catini - art. CALAR80/CALAR80SF - CASTR80 - CAPIR80L/CAPIR80E/CAPIR80M

# cielo

Catino rettangolare 80 con piano  
Catino rectangular 80 with shelf

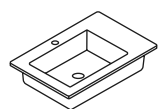

**lavabo / washbasin**  
art. CALAR80/CALAR80SF  
(senza foro/no tap hole)  
**peso netto / net weight:**

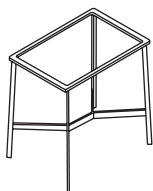

**struttura / framework**  
art. CASTR80  
**peso netto / net weight:**

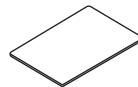

**piano / shelf**  
art. CAPIR80L/CAPIR80E/CAPIR80M  
**peso netto / net weight:**

Maggio 2026

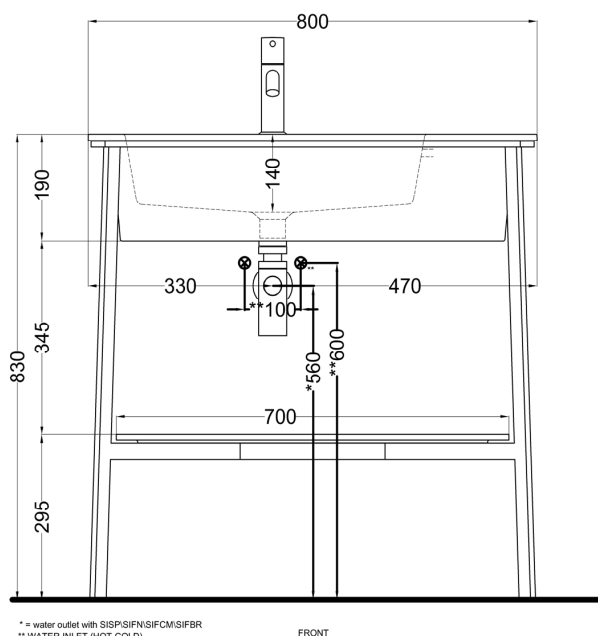
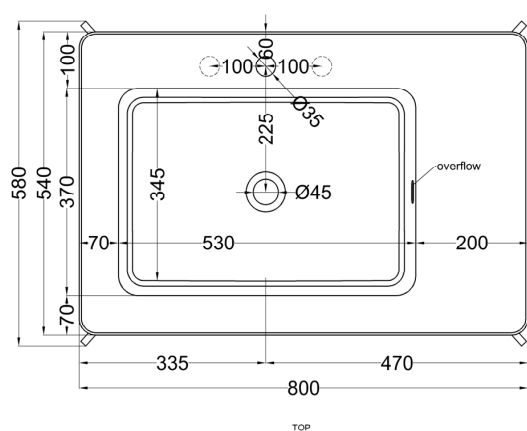

\* = water outlet with SISPS/SIFN/SIFCM/SIFBR  
\*\* WATER INI FT (HOT-COLD)

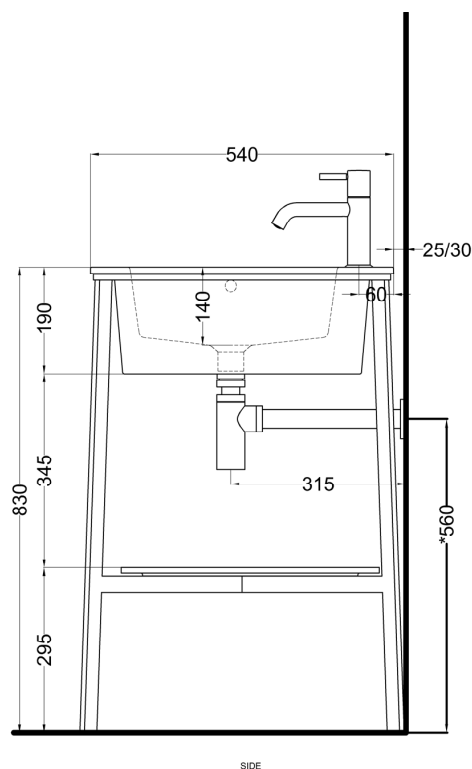

**ATTENZIONE:**  
Superfici, pesi e misure riportate possono presentare leggere differenze rispetto ai pezzi reali, in considerazione e accordo delle caratteristiche di tolleranza intrinseche del materiale ceramico e del suo processo produttivo. L'azienda si riserva di cambiare schede tecniche e caratteristiche di funzionamento degli articoli in ogni momento e senza necessità di preavviso.

**ATTENTION:**  
Surfaces, weights and dimensions can show some little differences compared to the real item, following typical intrinsic characteristics of ceramics material and production. The company reserves the right to change any technical specifications/ dimension and/or operating characteristics of the products at any time and without giving notice.

# I Catini - art. CALAR80/CALAR80SF - CASTR80 - CACR80L/CACR80E

# cielo

Catino rettangolare 80 con cassetto

Catino rectangular 80 with drawer

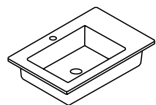

**lavabo / washbasin**  
art. CALAR80/CALAR80SF  
(senza foro/no tap hole)  
**peso netto / net weight:**

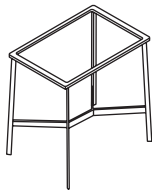

**struttura / framework**  
art. CASTR80  
**peso netto / net weight:**

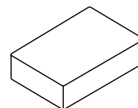

**cassetto / drawer**  
art. CACR80L/CACR80E  
**peso netto / net weight:**

Maggio 2026

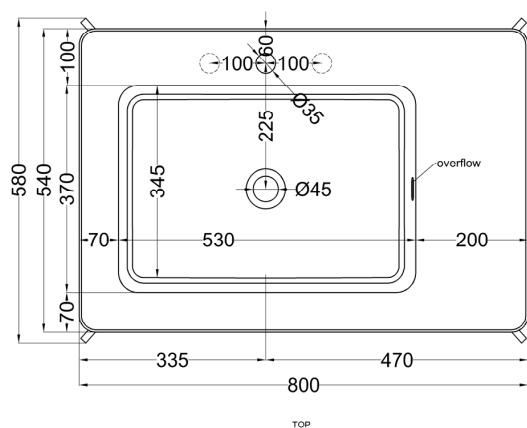

**apertura cassetto push and pull /**  
push-pull drawer opening system

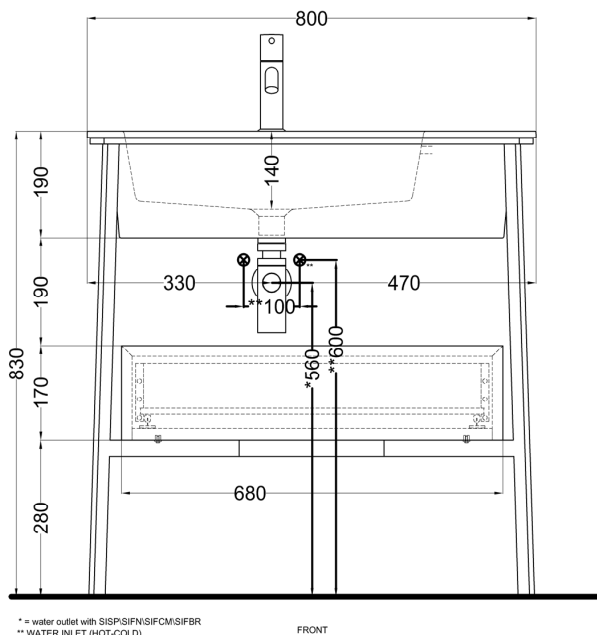

\* = water outlet with SISPS/SIFN/SIFCM/SIFBR  
\*\* WATER INI FT (HOT-COLD)

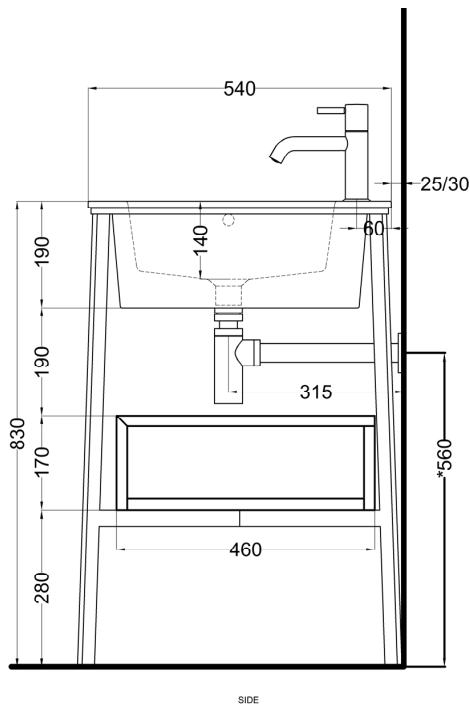

**ATTENZIONE:**  
Superfici, pesi e misure riportate possono presentare leggere differenze rispetto ai pezzi reali, in considerazione e accordo delle caratteristiche di tolleranza intrinseche del materiale ceramico e del suo processo produttivo. L'azienda si riserva di cambiare schede tecniche e caratteristiche di funzionamento degli articoli in ogni momento e senza necessità di preavviso.

**ATTENTION:**  
Surfaces, weights and dimensions can show some little differences compared to the real item, following typical intrinsic characteristics of ceramics material and production. The company reserves the right to change any technical specifications/ dimension and/or operating characteristics of the products at any time and without giving notice.